

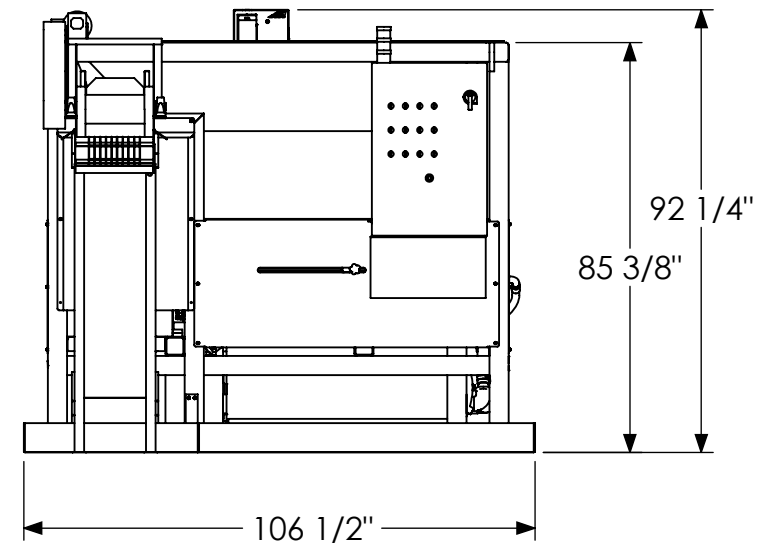

SHOWN WITH OPTIONAL
FEED RAM AND CONVEYOR

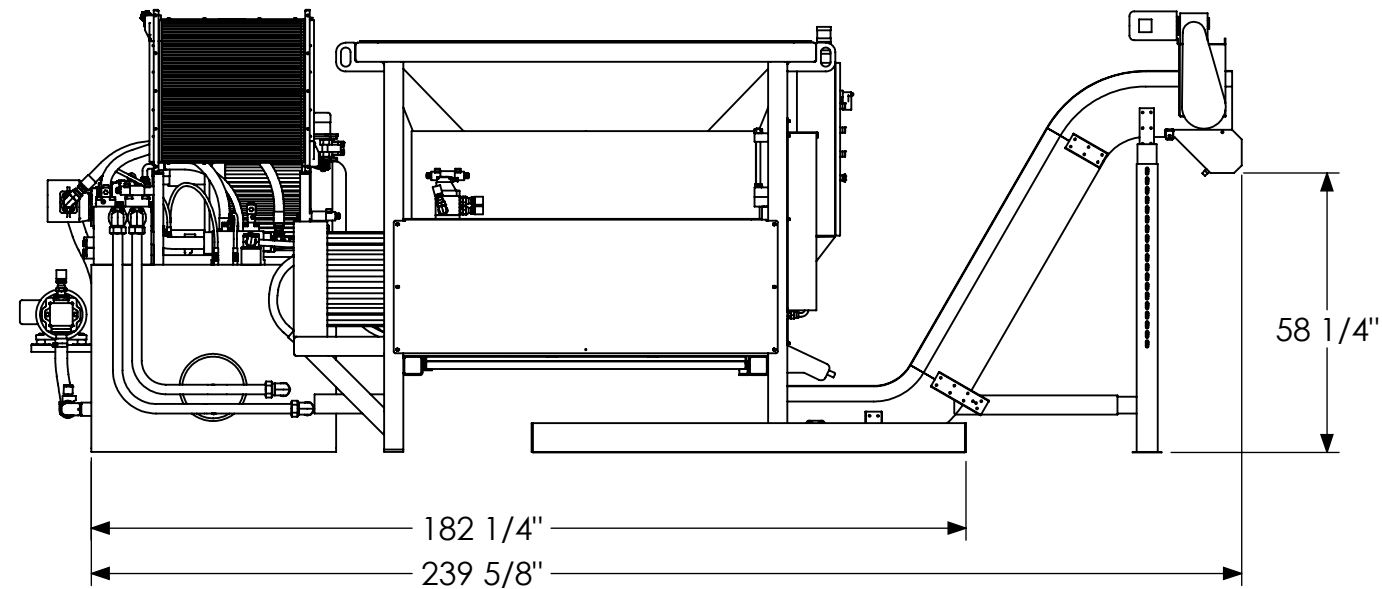

REVISION	E.N. NUMBER	DESCRIPTION	BY	DATE
CONFIDENTIAL INFORMATION		TOLERANCES: UNLESS NOTED OTHERWISE FRACTIONS + 1/32" .XX DECIMAL + .010 .XXX DECIMAL + .005 ANGLES ± 1/2° MACHINED SURFACES TO BE FINISHED TO 125 UNLESS OTHERWISE SPECIFIED DO NOT SCALE REMOVE ALL BURRS & SHARP EDGES	 9100 Van American Dr. Waco, Texas 76712	
This drawing and all information contained in it are the property of APPLIED RECOVERY SYSTEMS and may not be reproduced, disclosed to any other person or used in any manner except as authorized in writing by APPLIED RECOVERY SYSTEMS				
MATERIAL		SEE ABOVE	DESCRIPTION	
			ARS 2000-LAYOUT	
			DWN. BY MAW	DATE 9/15/2016
			CHK. BY	SCALE 1:40
			APPD BY	PAGE 1 OF 1
			DRAWING NO. ARS 2000-LAYOUT	